





MODE MONTAGE I SETUP INSTRUCTIES



V2023 16/05/2023

Castor Base Tent 27,5 m²

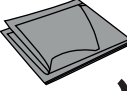
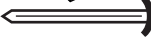

PACKING

-  (A) 6x RIDGE POLE (219 cm)
-  (B) 6x ROOF POLE (143 cm)
-  (C) 6x FOOT POLE (169 cm)
-  (D) 3x CROSS PIECE
-  (E) 6x CROSS PIECE

-  (F) 1x BATHTUB GROUNDSHEET
-  (X) 28x T-PEG
-  (Z) 40x NAIL PEG

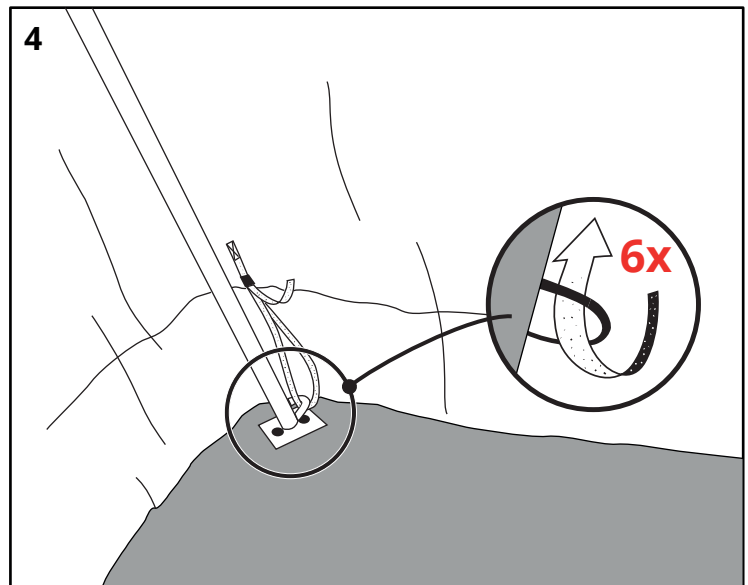
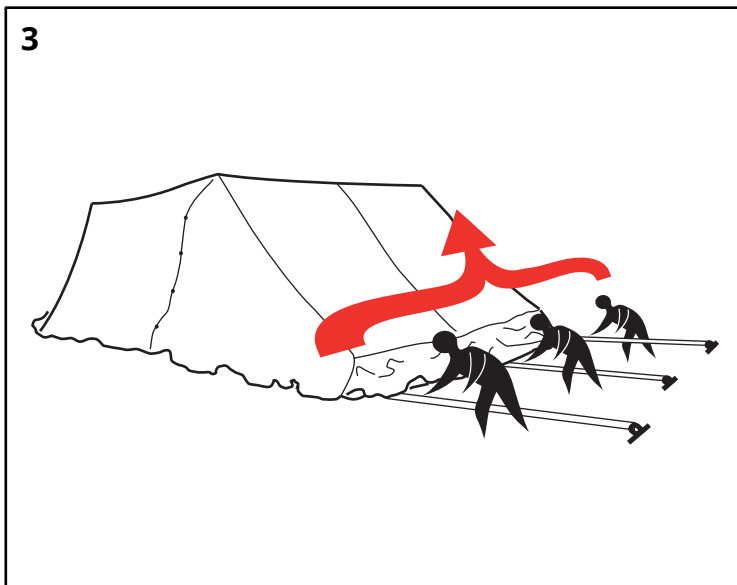
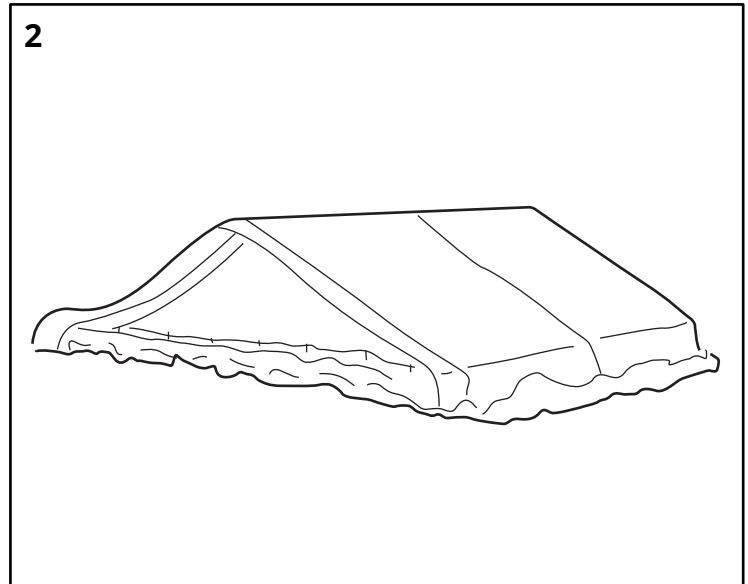
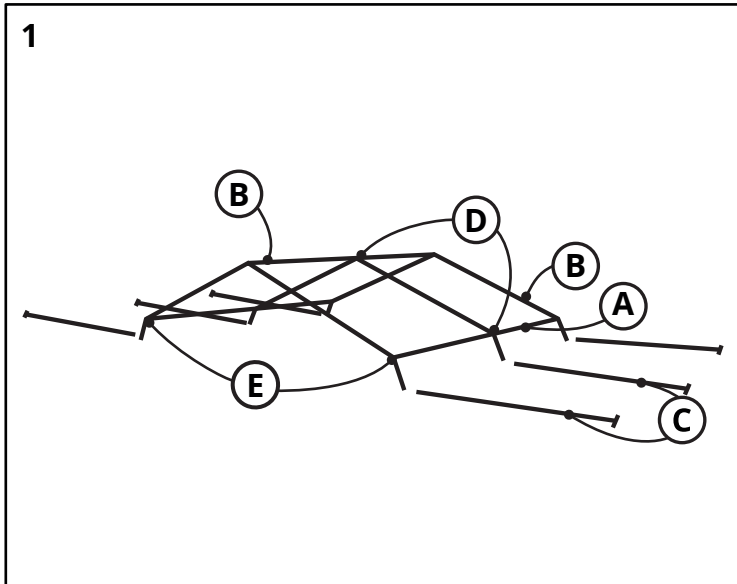

For more info on this tent, maintenance or repairs, check alpino.be.

MODE MONTAGE I SETUP INSTRUCTIES

V2023 16/05/2023

Castor Base Tent 27,5 m²

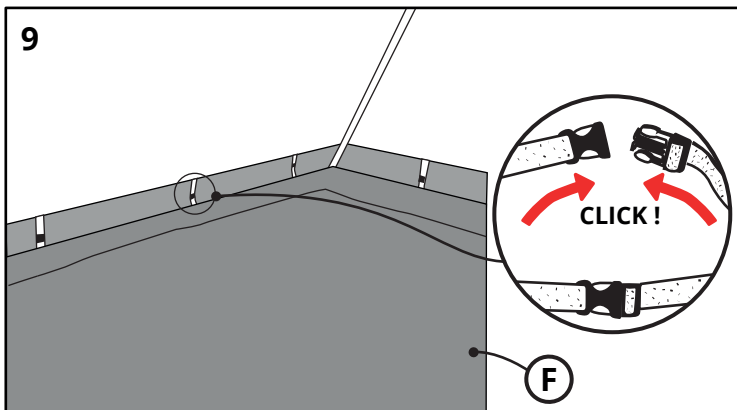
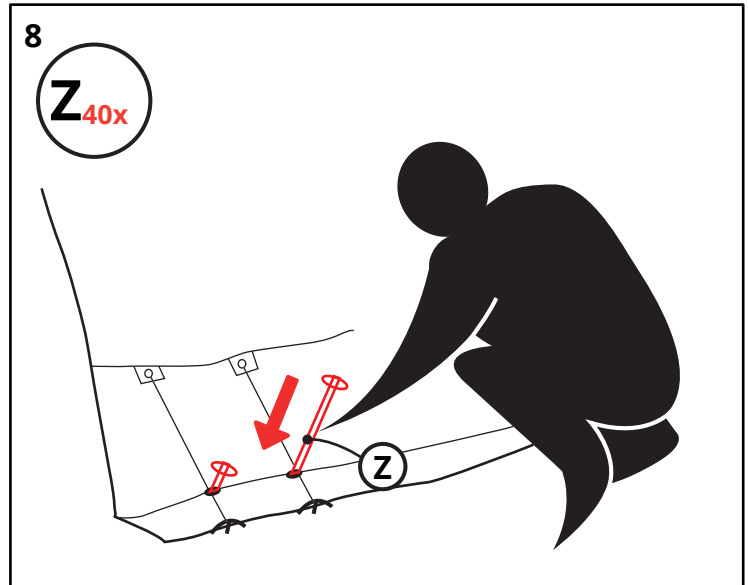
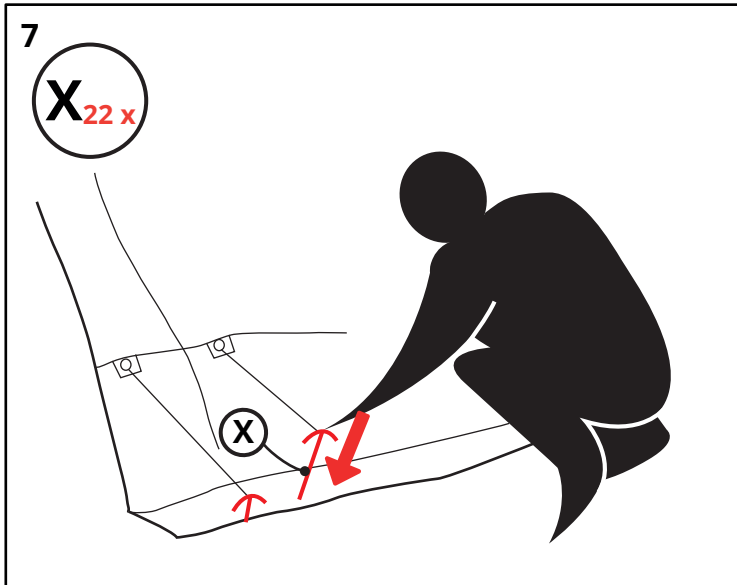
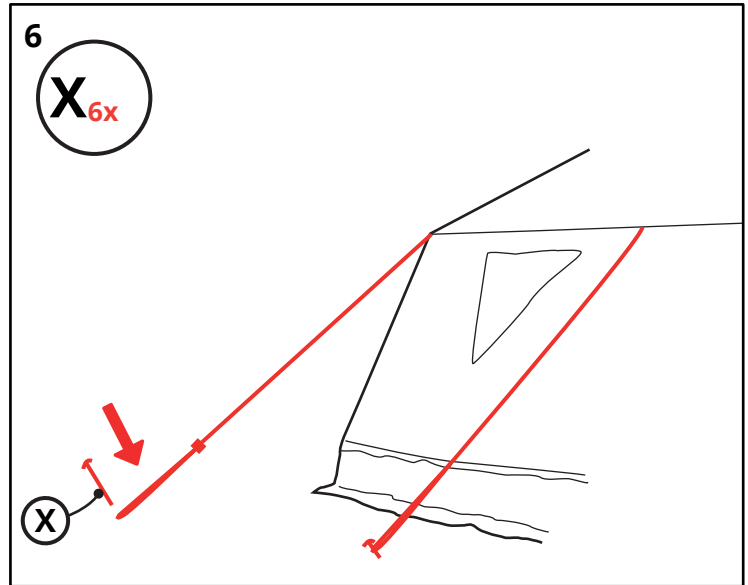
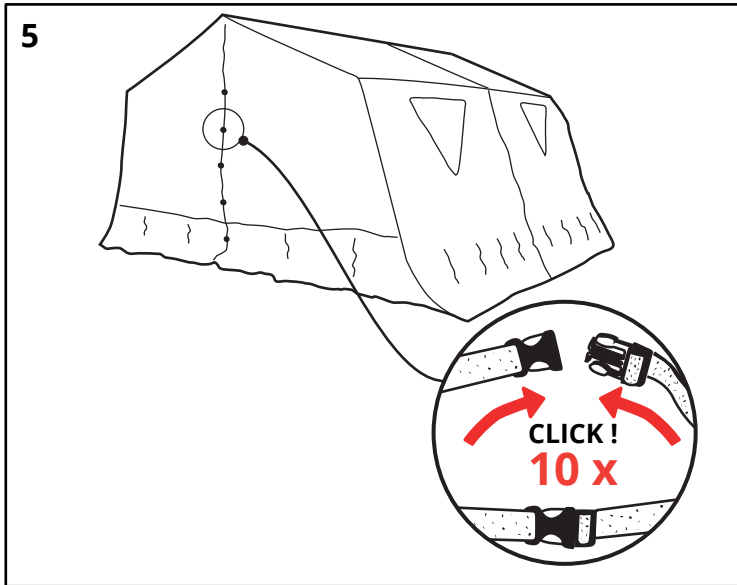

For more info on this tent, maintenance or repairs, check alpino.be.